

Non-isolated Diode Module, 70 Amps

Features

- Low voltage three-phase
- Easy construction
- High surge current capability
- Non-isolated



Voltage Ratings ($T_C = 25^\circ\text{C}$ unless otherwise specified)				
Parameter	Symbol	N3D70A30(R)	N3D70A40(R)	Units
Maximum Repetitive Peak Reverse Voltage	V_{RRM}	300	400	V
Maximum Non-Repetitive Peak Reverse Voltage	V_{RSM}	360	480	V
DC Reverse Voltage	$V_{R(DC)}$	240	320	V

Electrical Characteristics ($T_C = 25^\circ\text{C}$ unless otherwise noted)			
Parameter	Symbol	Values	Units
Maximum average forward current	$I_{F(AV)}$	70	A
Maximum average RMS forward current	I_{FRMS}	110	A
Maximum non-repetitive surge current	I_{FSM}	1400	A
Maximum I^2t for fusing	I^2t	9800	A^2s
Forward voltage drop	V_{FM}	1.25	V
Maximum Repetitive Peak Reverse Current	I_R	12	mA

Thermal & Mechanical Specifications ($T_C = 25^\circ\text{C}$ unless otherwise noted)			
Parameter	Symbol	Values	Units
Operating junction temperature range	T_J	-30 to +150	$^\circ\text{C}$
Storage temperature	T_{stg}	-30 to +125	$^\circ\text{C}$
Thermal resistance, junction to case	$R_{th(j-c)}$	0.40	$^\circ\text{C}/\text{W}$
Mounting torque	to heatsink	2.5	Nm
	to terminals	2.5	
Weight	W	240	g

Circuit Configuration

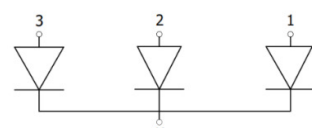
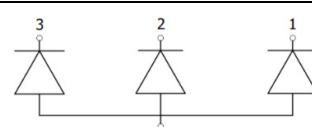
Circuit Description	Configuration Code	Circuit Drawing
Common cathode (base plate cathode)	N3D	
Common anode (base plate anode)	N3DR	

Package Outline

(All dimensions in mm)

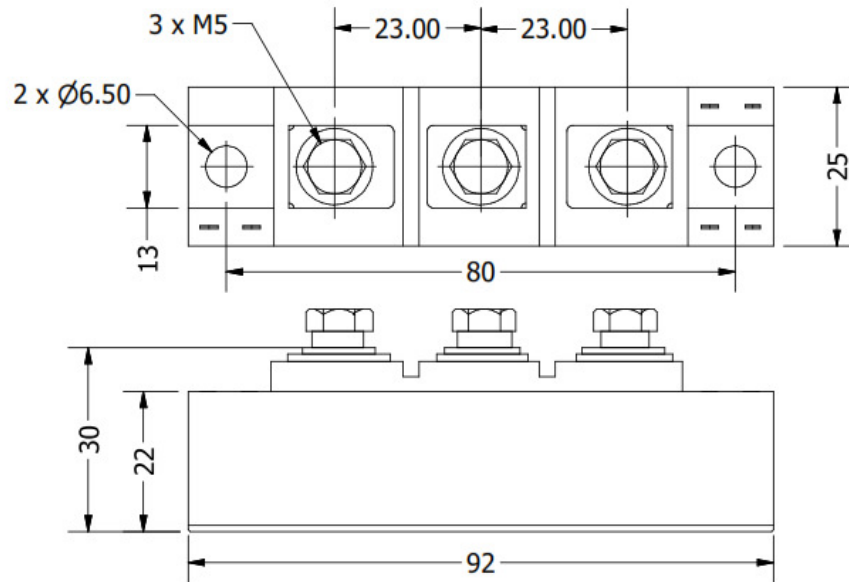

Ordering Table

N3D	70	A	40	R
1	2		3	4

- 1 – Half-bridge Diode Module
- 2 – Current Rating = $I_{F(AV)}$
- 3 – Voltage Code (see Voltage Ratings table)
- 4 – Polarity
 - > None = common cathode
 - > R = common anode