

Single Phase Bridge Rectifier, 160 Amps

Features

- Easy connections
- Excellent power volume ratio
- Insulated type

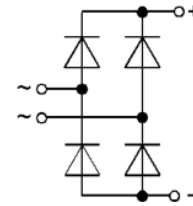

MDQ

Voltage Ratings ($T_J = 25^\circ\text{C}$ unless otherwise noted)				
Type number	Voltage code	V_{RRM} , Max. repetitive peak reverse voltage (V)	V_{RSM} , Max. non-repetitive peak reverse voltage (V)	I_{RRM} max @ T_J max (mA)
MDQ160	80	800	900	15
	100	1000	1100	
	120	1200	1300	
	140	1400	1500	
	160	1600	1700	



Electrical Specifications ($T_J = 25^\circ\text{C}$ unless otherwise noted)				
Parameters	Conditions	Symbol	Values	Units
Maximum DC output current	$T_C = 85^\circ\text{C}$	I_{DC}	160	A
Forward surge current (non-repetitive), one cycle	$f = 50$ Hz	I_{FSM}	1500	A
Fusing current		I^2t	11250	A^2s
Maximum forward voltage drop	$I_{FM} = 150\text{A}, T_J = 25^\circ\text{C}$	V_{FM}	1.35	V
RMS isolation voltage		V_{ISO}	3000	V

Thermal and Mechanical Specifications ($T_J = 25^\circ\text{C}$ unless otherwise noted)				
Parameters		Symbol	Values	Units
Maximum operating junction temperature range		T_J	- 40 to + 125	$^\circ\text{C}$
Maximum storage temperature range		T_{STG}	- 40 to + 125	$^\circ\text{C}$
Maximum thermal resistance, junction to case		$R_{th(J-C)}$	0.12	$^\circ\text{C}/\text{W}$
Mounting torque	to heatsink	F	$4 \pm 15\%$	Nm
	to terminal		$4 \pm 15\%$	
Approximate weight	Package – E	W	340	g
	Package – F		460	
	Package – S		295	

Package Outline

(All dimensions in mm)

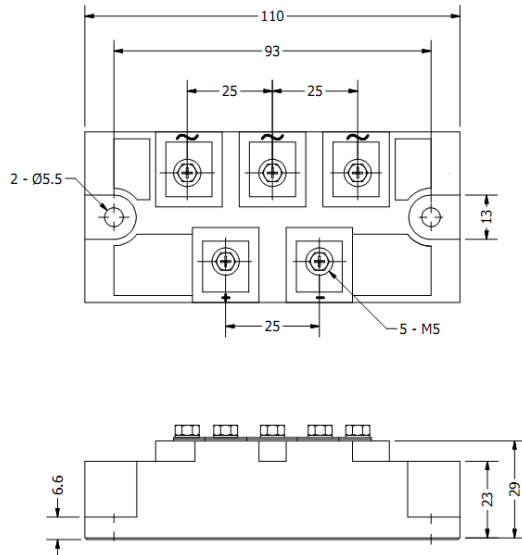

Package Type E

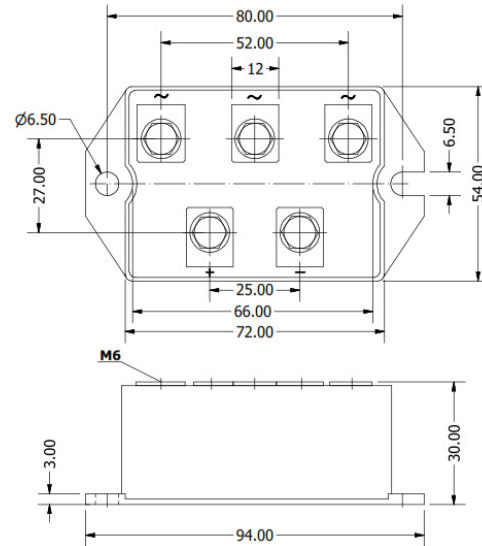

Package Type S

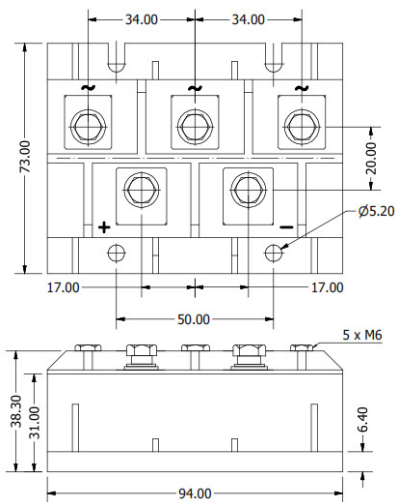

Package Type F

Ordering Table

MDQ	160	/	120
1	2		3

1 – Single-Phase Bridge

2 – Current = I_D

3 – Voltage Code x 10 = V_{RRM} (See Voltage Ratings Table)