

## Phase Control Thyristors, 125A

**Features**

- Improved glass passivation for high reliability
- Exceptional stability at high temperatures
- High di/dt and dv/dt capabilities
- Metric thread type available
- Low thermal resistance



TO-209AC (TO-94)

Voltage Ratings ( $T_J = 25^\circ\text{C}$ , unless otherwise noted)				
Type number	Voltage Code	$V_{\text{DRM}}/V_{\text{RRM}}$ , Maximum repetitive peak and off-state voltage (V)	$V_{\text{RSM}}$ , Maximum non-repetitive peak voltage (V)	$I_{\text{DRM}}/I_{\text{RRM}}$ , Maximum at $T_J = T_J$ Maximum (mA)
125NT	20	200	300	20
	40	400	500	
	60	600	700	
	80	800	900	
	100	1000	1100	
	120	1200	1300	
	160	1600	1700	

Electrical Ratings ( $T_J = 25^\circ\text{C}$ , unless otherwise noted)				
Parameters		Symbol	Values	Units
Maximum on-state average current	$T_J = 85^\circ\text{C}$	$I_{\text{T(AV)}}$	125	A
Maximum RMS on-state current		$I_{\text{T(RMS)}}$	196	A
Maximum peak, one cycle non-repetitive surge current	$T_J = 25^\circ\text{C}$ , 10 ms	$I_{\text{TSM}}$	3500	A
	$T_J = 130^\circ\text{C}$ , 10 ms		3000	
Maximum $I^2t$ for fusing	$T_J = 25^\circ\text{C}$ , 10 ms	$I^2t$	61250	$\text{A}^2\text{s}$
	$T_J = 130^\circ\text{C}$ , 10 ms		45000	
Maximum peak on-state voltage	$T_J = 25^\circ\text{C}$	$V_{\text{TM}}$	1.9	V
Maximum holding current	$T_J = 25^\circ\text{C}$	$I_{\text{H}}$	200	mA
Maximum latching current	$T_J = 25^\circ\text{C}$	$I_{\text{L}}$	400	mA
Maximum rate of rise of turn-on current	$T_J = T_J \text{ max.}$	di/dt	150	$\text{A}/\mu\text{s}$
Maximum critical rate of rise of off-state voltage	$T_J = T_J \text{ max.}$	dv/dt	500	$\text{V}/\mu\text{s}$
Maximum gate current required to trigger	$T_J = 25^\circ\text{C}$	$I_{\text{GT}}$	200	mA
Maximum gate voltage required to trigger	$T_J = 25^\circ\text{C}$	$V_{\text{GT}}$	3	V

Thermal and Mechanical Specifications ( $T_J = 25^\circ\text{C}$ , unless otherwise noted)			
Parameters	Symbol	Values	Units
Maximum operating junction temperature range	$T_J$	- 40 to +130	$^\circ\text{C}$
Maximum storage temperature range	$T_{\text{Stg}}$	- 50 to +150	$^\circ\text{C}$
Maximum thermal resistance, junction to case	$R_{\text{th(JC)}}$	0.18	$^\circ\text{C}/\text{W}$
Mounting torque	F	25	Nm
Approximate weight	W	250	g

## Package Outline

(All dimensions in mm)

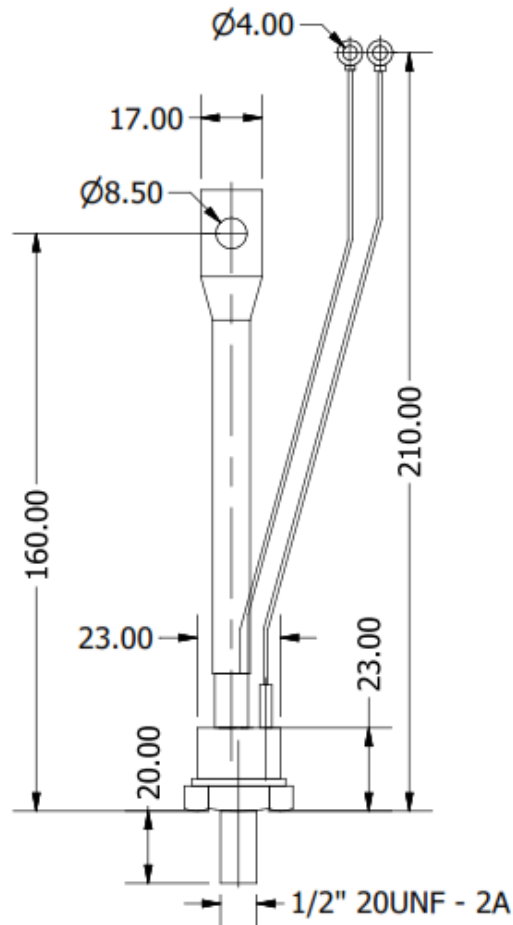

## Ordering Table

125	NT	120
1	2	3

1 – Current Rating =  $I_F (AV)$

2 – Phase Controlled Thyristor (SCR)

3 – Voltage x 10 =  $V_{RRM}$